

INSTRUCTIONS

for the

Sew-Ette

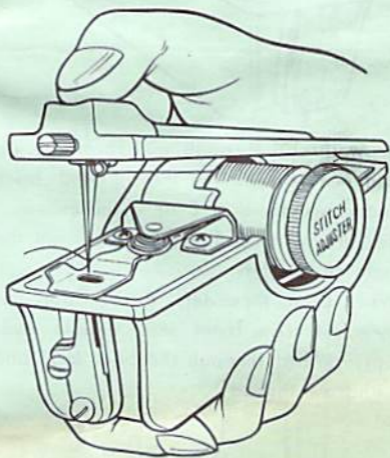

In order to take full advantage of everything that this machine can do for you, please read the directions carefully.

1. TO THREAD MACHINE:

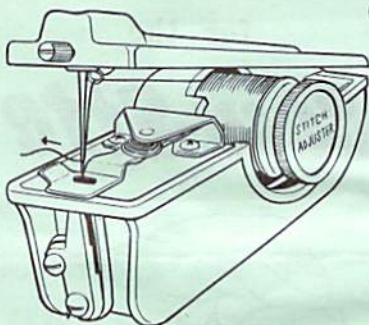

Draw thread through wire thread guide and needle eye. Pull thread end back under presser-arm 2 or 3 inches.

Be sure to thread needle eye from the right to the left.

When using threader, insert loop of threader from front into needle eye, pass thread through threader loop and withdraw thread.

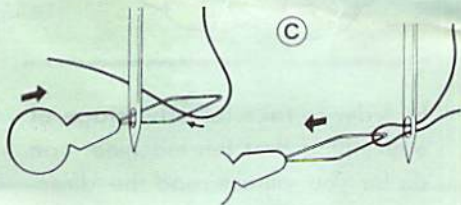

4. TO SEW BUTTONS:

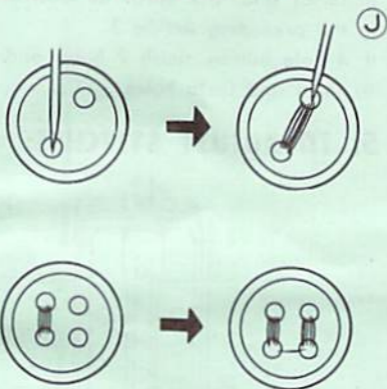

The sewing procedure is basically same. However, it requires some practice to sew buttons as this machine sews from the left to the right and not the reverse. Place fabric and button on presser-arm. Lower needle into first hole, all the way down, and release all the way up. Move button slightly to the left so that needle may thrust into another hole. Press needle into another hole.

Turn button half-way round, and press needle into first hole, turn button back half-way round and press needle into another hole. Repeat the sewing action until button is secured.

When sewing button is finished, remove material and lock stitch as illustration in the preceding Article 3.

If 4 hole button, finish 2 holes and go to third and fourth holes.

5. TO ADJUST STITCHES:

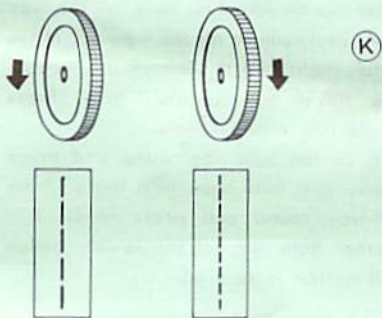
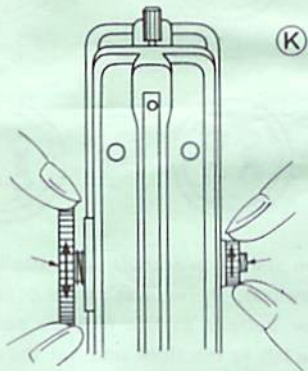

Loosen and remove lock-nut. Then unscrew stitch adjuster so that stitch adjuster, tension spring and thread spool can be removed from housing.

Change thread spool and fit all items, using same procedure, back into housing. Adjust stitch adjuster and tighten lock-nut firmly to begin sewing again.

Thread spool must be of smaller dimensions than attached one.

Be sure that #80 cotton yarn or silk yarn is for #9 or #11 needle, #50 or #60 cotton yarn for #14 needle, and #30 or #40 cotton yarn for #16 needle.

Printed in Japan.



Ⓔ

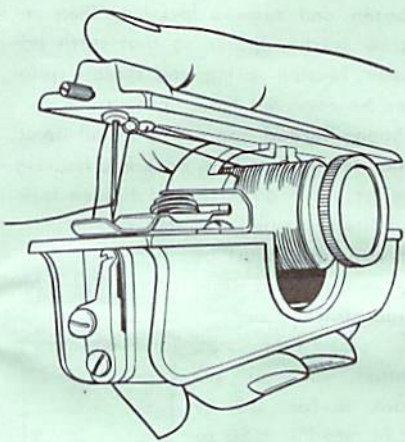

Ⓕ

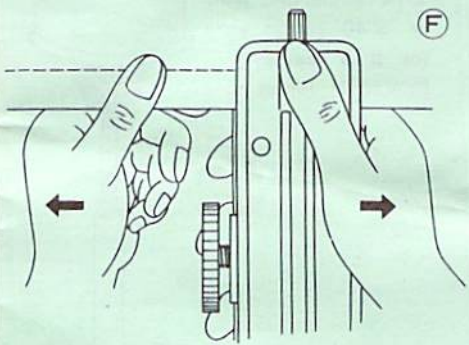

3. TO REMOVE FABRIC AND LOCK STITCH:

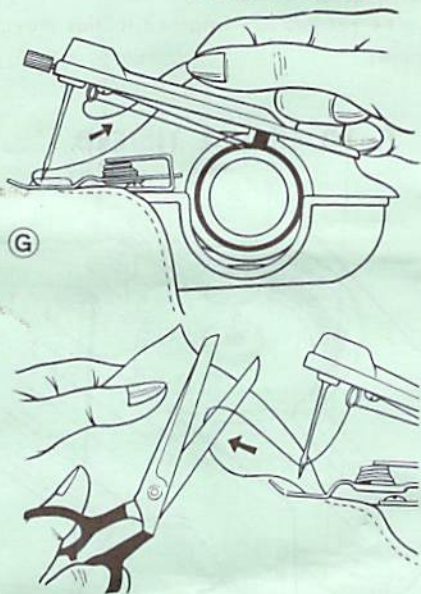

When sewing is finished, loosen the thread between needle eye and wire thread guide by pulling 4 or 5 inches of thread towards the rear.

Then, pull out this slack thread to the left and cut thread with scissors.

Lift presser-arm with index finger and gently remove fabric by pulling it towards the left, lifting fabric slightly.

Be sure to use standard household sewing machine needle (15×1) #9, #11, #14 or #16.

(#14 needles are attached to this machine).

7. TO CHANGE THREAD SPOOL:

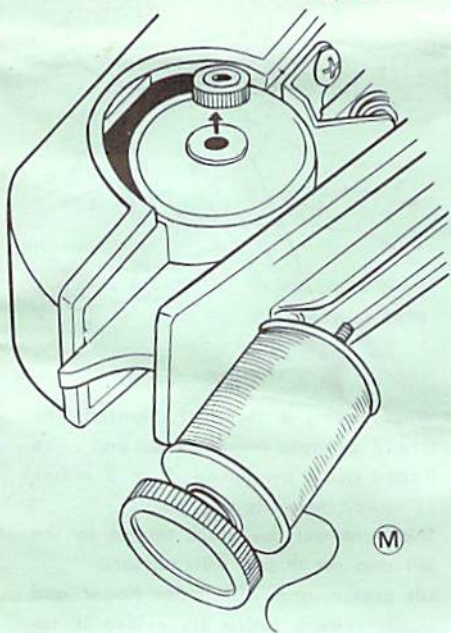

Loosen lock-nut by moving it anti-clockwise. This will loosen stitch adjuster.

For larger stitches turn stitch adjuster counter-clockwise; for smaller stitches turn it clockwise.

After getting desired stitch tighten lock-nut by moving it clockwise.

Pulling fabric also has some bearing on stitch size; the faster pull, the larger stitches.

6. TO CHANGE NEEDLE:

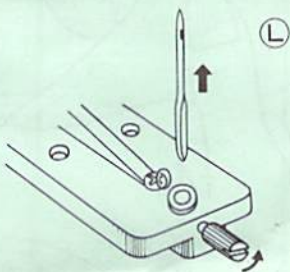

Turn machine upside down, loosen needle set screw and pull out old needle. Fit new needle into hole as far as it will go with its flat side facing needle set screw, and tighten firmly with fingers. Tighten the screw again with coin or screw driver.

Draw thread end on the underside of fabric, pass thread end through loop of final stitch and fasten it to avoid untying.

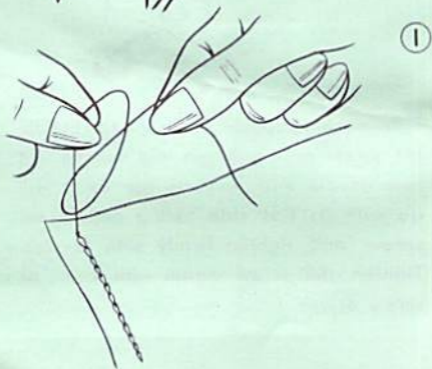
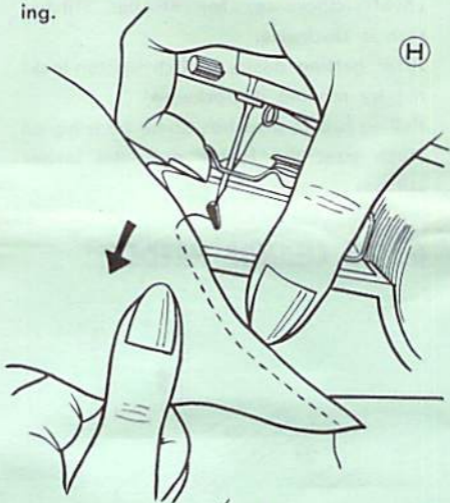

2. TO START SEWING:

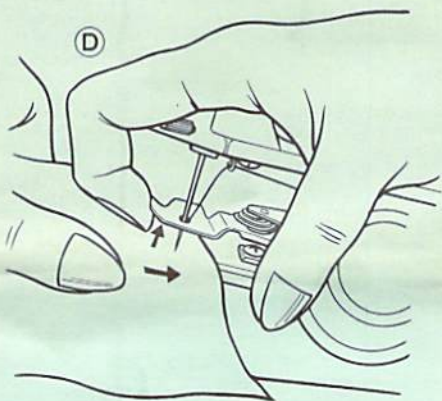

Lift presser-arm with index finger and insert fabric.

Hold machine in right hand and place thumb on top near front-centre grasping bottom of machine naturally with four fingers.

Start to sew by pressing machine all the way down and all the way up; move machine to the right at the same time, gently drawing fabric through left hand. Move machine only to the right when sewing.

Do not press machine only half-way as stitching may skip.

UNITED STATES OF AMERICA



Faint, illegible text, possibly bleed-through from the reverse side of the page. The text is too light to read accurately but appears to be organized into several paragraphs.